

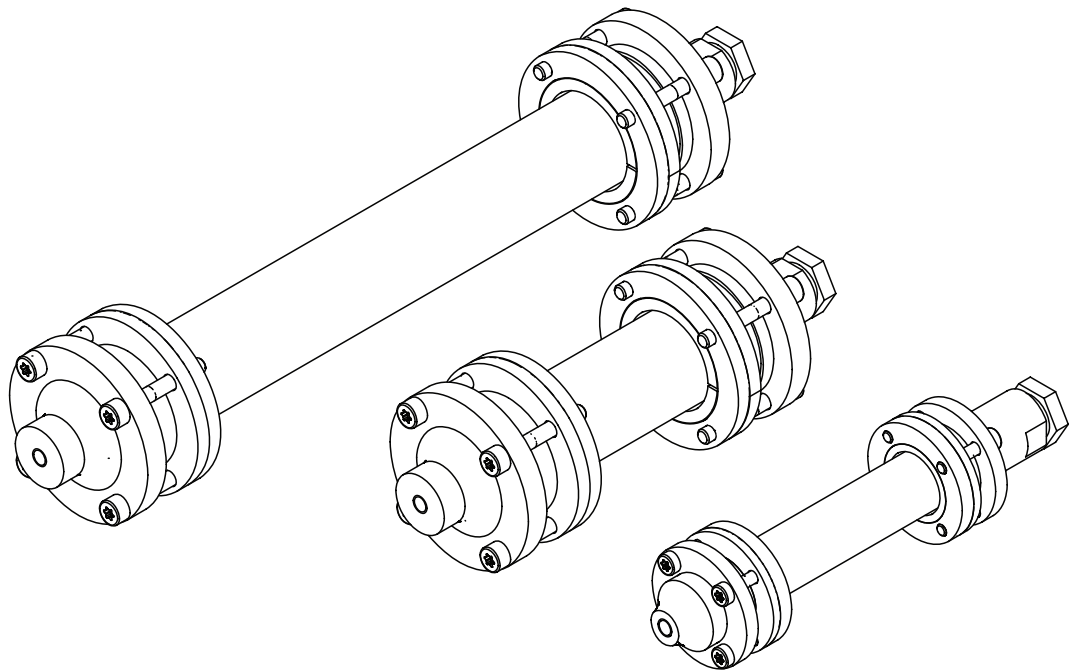

GlasPure Columns

Technical data sheet

When purification has to be scaled up, GlasPure offers maximum flexibility in terms of scale and separation requirements. The glass columns are designed for sample amounts over 300 g and pressure up to 50 bar (725 psi).



GlasPure columns

Empty glass columns, which can be filled by the user; the column packaging can be discarded at any time and the column repacked; all GlasPure columns are delivered as single pieces.

Inner Diameter (mm)	Column length 100 mm	Column length 230 mm	Column length 460 mm	Column length 920 mm	Pressure range (bar / psi)
ID 15	044030	044031	044032	044033	0 - 50 / 725
ID 26	044035	044036	044037	044038	0 - 40 / 580
ID 36	-	044040	044041	044042	0 - 30 / 435
ID 49	-	044044	044045	044046	0 - 20 / 290
ID 70	-	044048	044049	044050	0 - 15 / 218
ID 100	-	044048	044049	044050	0 - 10 / 145

Capacity specifications

Inner Diameter (mm)	Column length 100 mm	Column length 230 mm	Column length 460 mm	Column length 920 mm
ID 15	9	20	40	80
ID 26	25	65	130	260
ID 36	-	115	235	470
ID 49	-	230	460	920
ID 70	-	470	940	1800
ID 100	-	935	1850	3700

Accessories

Pre columns

	Order no.
Pre column small for GlasPure with ID 15, 26, 36 and 49 mm (1 pc.)	044026
Pre column large for GlasPure with ID 70 and 100 mm (1 pc.)	044028

Filling kits

	Order no.
Dry filling set for GlasPure ID 15-46 mm	044058
Adapter for dry filling set to fill GlasPure ID 70-100 mm	044059
Slurry filling set for GlasPure ID 15-26 mm	044057
Slurry filling set for GlasPure ID 36-49 mm	044060

Holders

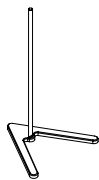
	Order no.	Image
Stand. V stand with rod, 650 mm	11069158	
Cross sleeve (1 pc.)	027344	

Pivoting clamps

	Order no.
Pivoting clamp for GlasPure ID 15 mm (1 pc.)	044857
Pivoting clamp for GlasPure ID 26 mm (1 pc.)	044858
Pivoting clamp for GlasPure ID 36 mm (1 pc.)	044859
Pivoting clamp for GlasPure ID 49 mm (1 pc.)	044860
Pivoting clamp for GlasPure ID 70 mm (1 pc.)	044861
Pivoting clamp for GlasPure ID 100 mm (1 pc.)	044862